



26.5 GHz SMA-2.9 LATCHING S.P.4 T. SWITCH

OPTIONS : INDICATOR / TTL DRIVE / SUPP.DIODES

R F CHARACTERISTICS

NUMBER OF WAYS : 4
 FREQUENCY RANGE : 0 - 26.5 GHz
 IMPEDANCE : 50 Ohms

FREQUENCY (GHz)	0 - 6	6 -12.4	12.4- 18	18 -26.5
V.S.W.R <=	1.30	1.40	1.50	1.70
INSERT. LOSS <=	0.20 dB	0.40 dB	0.50 dB	0.70 dB
ISOLATION >=	70 dB	60 dB	60 dB	55 dB
AVER. POWER (*)	40 W	25 W	15 W	10 W

ELECTRICAL CHARACTERISTICS

ACTUATOR : LATCHING
 NOMINAL CURRENT AT 25° C (±10%) : 125 mA / RESET : 500 mA (**)
 ACTUATOR VOLTAGE (Vcc) : 28V (24 to 30V) / NEGATIVE COMMON
 TERMINALS : solder pins (250°C max./30 sec.)
 INDICATOR RATING : 1 W / 30 V / 100 mA
 TTL INPUTS (E) - High level : 2.2 to 5.5V / 800µA at 5V
 - Low level : 0 to 0.8V / 20µA at 0.8V

MECHANICAL CHARACTERISTICS

CONNECTORS : SMA 2.9 fem.per MIL C 39012
 LIFE : 2.000.000 cycles per position
 SWITCHING TIME (nominal voltage;25° C) : < 15 ms
 CONSTRUCTION : splashproof
 WEIGHT : < 220 g

ENVIRONMENTAL CHARACTERISTICS

OPERATING TEMPERATURE RANGE (°C) : -40 , +85
 STORAGE TEMPERATURE RANGE (°C) : -55 , +85

(* : average power at 25° C per RF path)
 (** RESET : supply voltage time 1sec. max./duty cycle 10%)

This information is given as an indication. In the continual goal to improve our products, we reserve the right to make any modifications judged necessary

4112-9212

DRAWING

General tolerance: ± 0,5 mm

R573 733 420

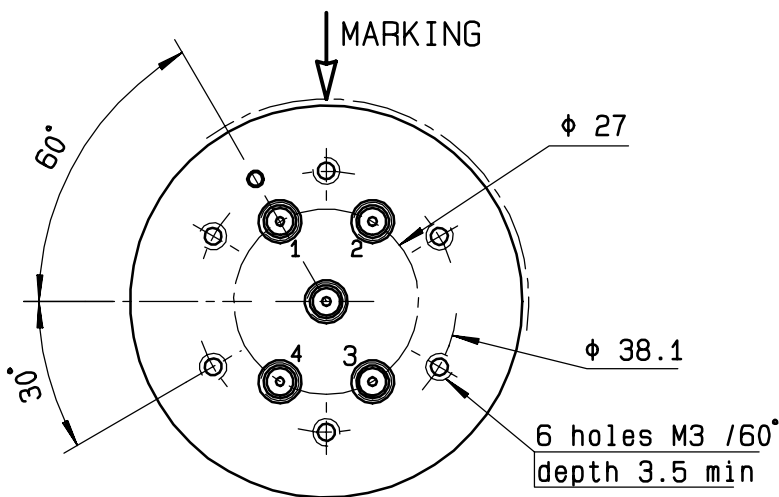

TTL input	RF continuity	Ind.
RESET = 1	All ports open	--
E1 = 1	IN ↔ 1	D.E
E2 = 1	IN ↔ 2	D.F
E3 = 1	IN ↔ 3	D.G
E4 = 1	IN ↔ 4	D.H

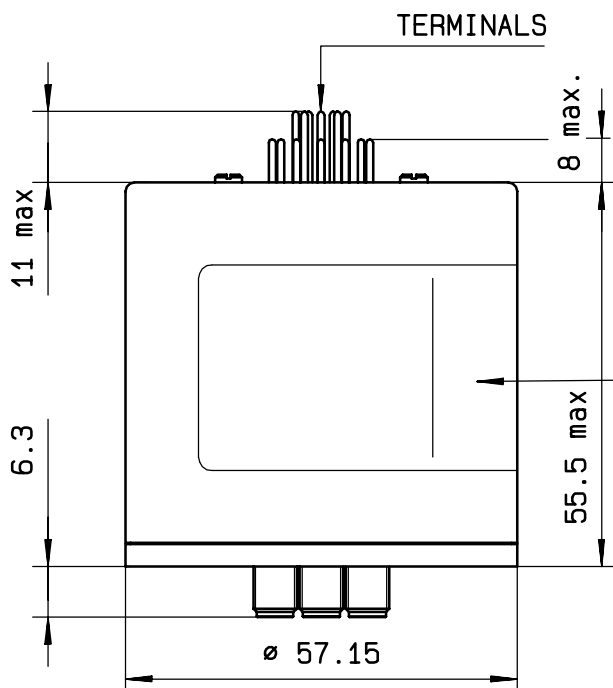

MARKING TOP VIEW (TERMINALS)

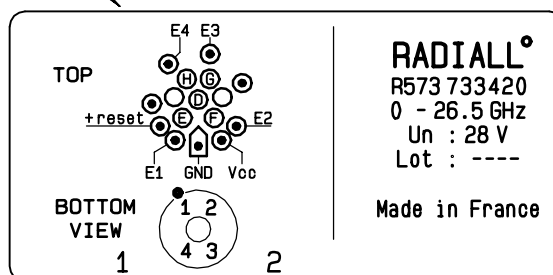

SCHEMATIC DIAGRAM

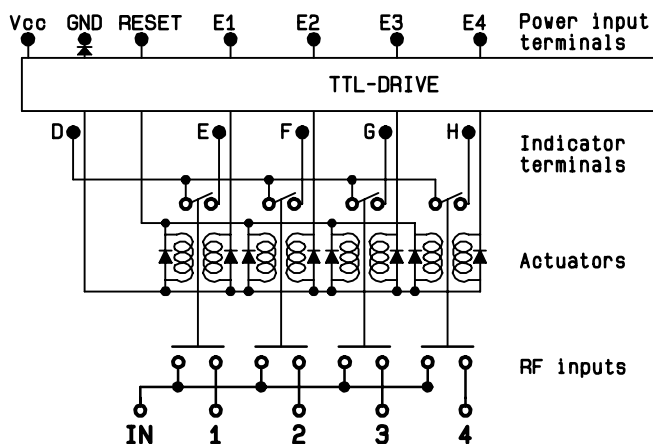

4113-9212 This information is given as an indication. In the continual goal to improve our products, we reserve the right to make any modifications judged necessary